



TECHNICAL NOTE 02/2018

Radiator Support

19.03.2018

# /Radiator brackets with Silentblocks

Dear Customers

We have added silentblocks on the radiator brackets for CUPRA TCR cars for help better withstand small impacts that the bumper might receive

New parts available on the VW Group Motorsport online platform:

<http://vwgroupmotorsport-onlineplatform.com/>

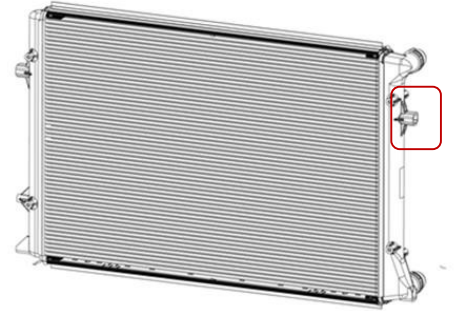
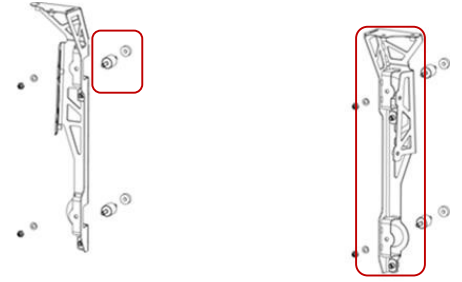
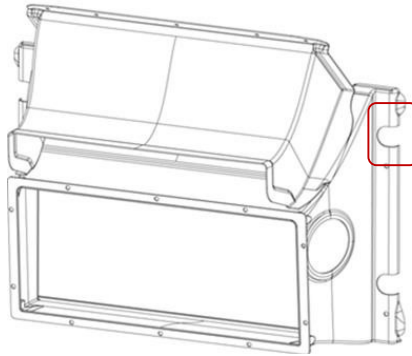

## /Parts

<b>Reference</b>	<b>Description</b>	<b>Qty.</b>	<b>Information</b>
5F6190251	Water radiator	1	*2017 part with new fixation threat & bolts
5F6805594A	W. radiator air duct	1	*2017 part with small cutouts
5F6805323C	Radiator bracket	1	New geometry
5F6805324C	Radiator bracket	1	New geometry
VN0008086000	Silentblocks double threat	4	New
VN0003090420	Lock nut M6 DIN985	4	New
VN0002000710	Flat washer Ø6 DIN125	4	New
5F6805355	Spacer	4	New

*Radiator brackets with silentblocks are already installed on 2018 CUPRA TCR cars*

*Previous radiator brackets are no longer available. In case of need you have to install the complete new package*

*\*You can rework the already existing water radiator and air duct, just check them carefully before*

*\*New Ref: 5F6190251 "Radiator" includes 4 fixing bolts that permit to assemble it on the old and new package*

## /Adaptation instructions

Use a M6 x 125 tap to re-thread the hole in the four fixing points. Be careful, do not punch the radiator.

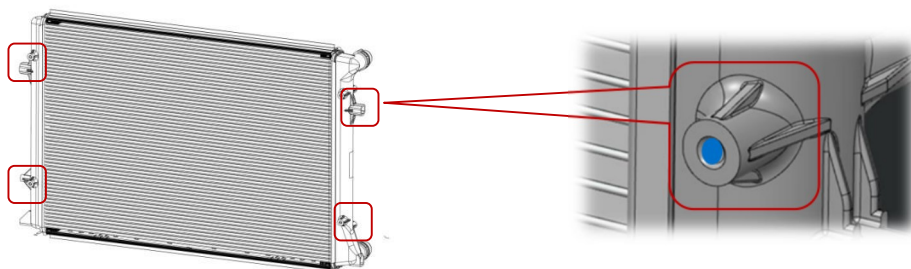

Place the air duct on the radiator over its 4 fixations and mark around. Cut as shown in the picture.

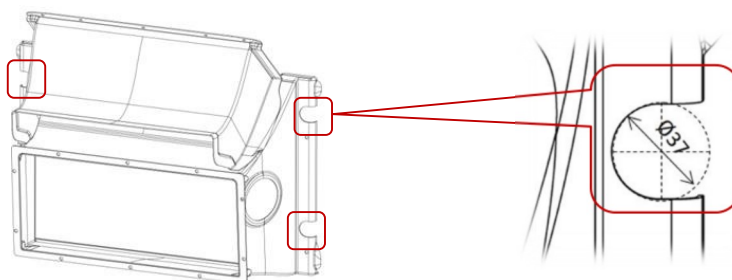

# /Adaptation instructions

Water radiator thread adaptation:

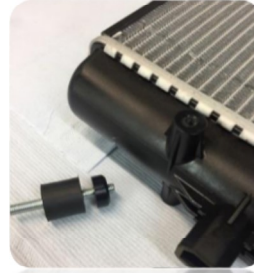
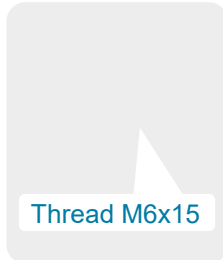
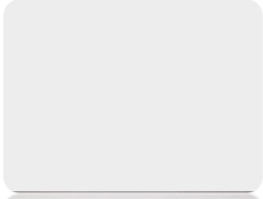

Water radiator with silentblocks assembly:

